



# CB-S24

## 2-Way Active Chilled Beam INSTALLATION, OPERATION, & MAINTENANCE (IOM) MANUAL

**General Information**

1.1	Introduction	3
1.2	Safety	3
1.3	Symbols used in this Manual	3
1.4	Receiving, Inspection and Storage	3

**Product Description and Installation Preparation**

2.1	Product Overview	4
2.2	Construction Description	4
2.3	Application Precautions	4
2.4	Preparation for Installation	4
2.4.1	Items Provided by Installer	4
2.4.2	Unit Weights	4
2.5	Dimensional Data	5

**Installation**

3.1	General Procedure	6
3.2	Installation Considerations	6
3.3	Installing the CB-S24	6-7
3.4	Water Connections	8
3.4.1	Water Connections Identification	8
3.5	Air Connections	9
3.6	Flushing the Water Piping System	9
3.7	Filling and Venting the Water System	9
3.8	Connect Condensate Drain	9

**Commissioning**

4.1	Waterside Commissioning	10
4.2	Airside Commissioning	10
4.2.1	Airside Commissioning and K-Factor Table	10-11

**Maintenance**

5.1	Cleaning Instructions	12
5.2	Replacement Parts	12

**Troubleshooting**

6.1	Symptoms & Solutions	13
-----	----------------------	----

**Terms and Conditions**

7.1	Manufacturer's Representations & Warranties	14-15
-----	--	-------

### 1.1 INTRODUCTION



**Important!**

You must read all instructions prior to the installation, operation, or maintenance of this product!

The Carson Solutions 24 inch wide comes standard with a slanted dual hydronic heat exchanger, linear discharge slots, and condensate drain pan. The (CB-S24) active chilled beam is designed to provide high cooling and heating capacities by conditioning the room's air while simultaneously supplying a fresh conditioned, code required, primary air to the occupied area. The central Air Handling Unit (AHU) or Dedicated Outdoor Air Supply (DOAS), supplies the chilled beam with tempered and dehumidified conditioned primary air to maintain the required ventilation and humidity control of the space while addressing the latent load. The remaining space sensible loads are addressed with the integrated hydronic coil inside the chilled beam housing. The use of linear induction nozzles within the chilled beam induces the room's return air through the beam's perforated face grille, then across a slant mounted hydronic coil which spans the full length of the beam housing.

During the induction process, the nozzles also discharge the fresh conditioned primary air, delivered by the AHU or DOAS unit, at selected velocities causing the induced room air to be pulled into the beam's mixing chamber and redistributed into the space by the beam's integrated linear discharge slots. Both the induced room air and the supplied primary air mixes and delivers the combined airstreams into the occupied zone. This process increases efficiency which maximizes cooling and heating capacity per unit of mixed air flow streams to deliver premium performance and thermal comfort. The air delivery process from the chilled beam has inherent characteristics related to temperature, velocity, and airflow throw. Chilled beams airflow throw characteristics relates to the velocity and temperature differentials that diminish at a rate that is directly proportional to the distance the air has traveled within the space. It is important to understand the room and occupant load and the space layout to properly layout desired chilled beams.

### 1.2 SAFETY

The customer must use qualified personnel and follow all applicable building codes and safety regulations when installing, commissioning, and performing maintenance of this product. Eye protection and gloves should be worn at all times when handling the product.

Consult all local building, occupational safety and other codes applicable to the installation.

Please pay particular attention to the symbols used throughout the manual that indicate safety related issues, warnings and important notices or information; read the complete manual before installation and be familiar with the meaning of the safety symbols in the next section 1.3.

### 1.3 SYMBOLS USED IN THIS MANUAL

When reading this manual, particular attention must be given to the parts marked with the following symbols:



**Warning!**

Indicates a potentially dangerous situation for the product and the environment.



**Important!**

Designation of a danger that can cause personal injury or damage to property.



**Note!**

Indicates important notices or information.

### 1.4 RECEIVING, INSPECTION AND STORAGE



**Fragile!**

Handle with care. The CB-S24 should not be handled using the water pipes which may cause damage to the unit.

All Carson Solutions products are inspected prior to shipment to ensure the highest quality. The CB-S24 units are packed and labeled in individual cardboard packages.

Upon receipt of the CB-S24 shipment, conduct a thorough inspection of the outer packaging and the pallets for possible damage. If damage has occurred during shipping, indicate the damaged items on the delivery papers immediately and inspect the CB-S24 units contained in those containers for damage.

If damage has occurred during shipping, immediately file a claim with the carrier.

Refer to the Manufacturer's Representations and Warranties on pages 14-15 of this manual for detailed handling instructions and damage reporting procedures.



**Note!**

The CB-S24 units should not be removed from its individual package for storage. Do not unpack units until they have been moved to the installation location and just before installation is to begin.

Chilled Beams should be stored in a clean and dry location. If the chilled beams remain packaged as delivered (strapped and wrapped on the pallet), they can be stored as delivered (do not stack the pallets). If the packaged chilled beams are removed from the pallet, they should not be stacked more than four high.



## 2.1 PRODUCT OVERVIEW

The CB-S24 is supplied with a 2-way air throw pattern to provide optimal thermal comfort. Currently available are: four types of hydronic coils, a two-pipe system for cooling or heating using a changeover valve and a four-pipe system which enables any room to be cooled or heated independently. Both two and four-piped hydronic coils can be manufactured in a single or dual circuit arrangement depending on performance needs. The CB-S24 chilled beam can also be selected with four nozzle configurations depending on induction ratios needed to meet space load requirements. Four variable inlet sizes are selectable based upon optional chilled beam lengths from 2-8ft. Integration into grid style suspended ceiling systems can easily be accommodated with our three boarder style options along with an exposed mounting beam for open room or hallway areas. The condensate drain pan come standard with a 1/4" drain connection and is capped from the factory.

The CB-S24 chilled beams should be installed in the quantities, sizes, and configurations shown on the project plans and performance schedules.

## 2.2 CONSTRUCTION DESCRIPTION

The CB-S24 chilled beam is manufactured by Carson Solutions with the following details:

- Single primary round air connection
- A series of induction nozzles
- 2-way air throw discharge linear slots
- Integral hydronic coil with 1/2" male NPT threaded fittings
- Condensate drain pan with capped 1/4" drain pipe fitting
- Removable and reversible swing perforated intake grille
- 4-8 fixed mounting brackets with (3) 1" slots for 3/8" rods
- 20ga steel construction
- Powdercoat casing with matching border style for T-bar ceiling grids
- Heavy gauge fixed mounting brackets
- Integrated linear discharge slots

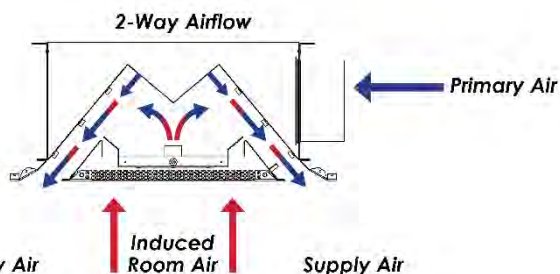
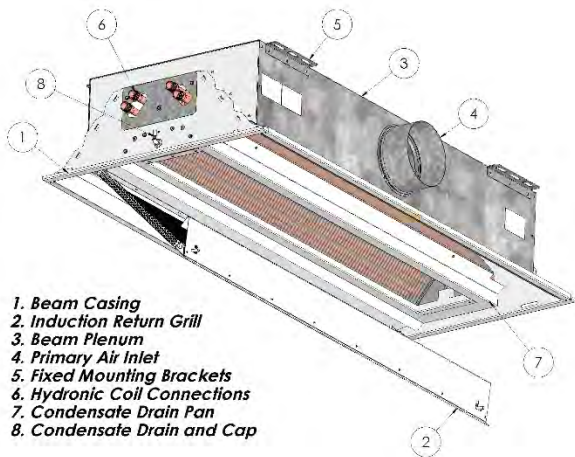

## 2.3 APPLICATION PRECAUTIONS

When in cooling mode, the entering water temperature to the CB-S24 chilled beam hydronic coil should be operated warmer than the space dew point temperature in order to prevent condensation.

Extreme latent load applications may, however, require lower chilled water temperatures to be used to condense moisture from the recirculated air during the reconditioning process.

## 2.4 PREPARATION FOR INSTALLATION



### Important!

Installation must be performed by properly trained and authorized personnel only! Read all instructions before beginning installation.

### 2.4.1 ITEMS PROVIDED BY INSTALLER

Installer to provide (according to all applicable local building codes):

- Proper PPE should be used by the installer
- 2 ladders or scaffolding, or scissors lift table
- Level and measure equipment
- Tools such as wrenches, plyers, screw drivers, and drills
- Mounting suspension methods consisting of pre-stressed adjustable hanging wire or 3/8" threaded rods and suspension nuts
- Uni-strut support rails (if required)
- Hydronic piping system
- Female 1/2" NPT connections or flexible stainless steel hoses
- Water flow regulators and strainers if applicable
- Manual shut-off valve for each pipe run (recommended) supply and return water circuits (unless factory furnished flexible stainless steel hoses are included with product order) or hard connections
- Sheetmetal or flexible duct work with primary air dampers to control air volume
- Air-side balancing and/or control devices as specified in the project plans and specifications
- Condensate pumping system and piping

### 2.4.2 UNIT WEIGHTS

(Add 7% for to values below for water weight)

CB-S24 Unit Size	Standard Borders	Exposed Mounted
2ft	38 lbs	43 lbs
3ft	58 lbs	63 lbs
4ft	74 lbs	82 lbs
5ft	100 lbs	110 lbs
6ft	136 lbs	148 lbs
7ft	152 lbs	162 lbs
8ft	168 lbs	180 lbs

2.5 DIMENSIONAL DATA

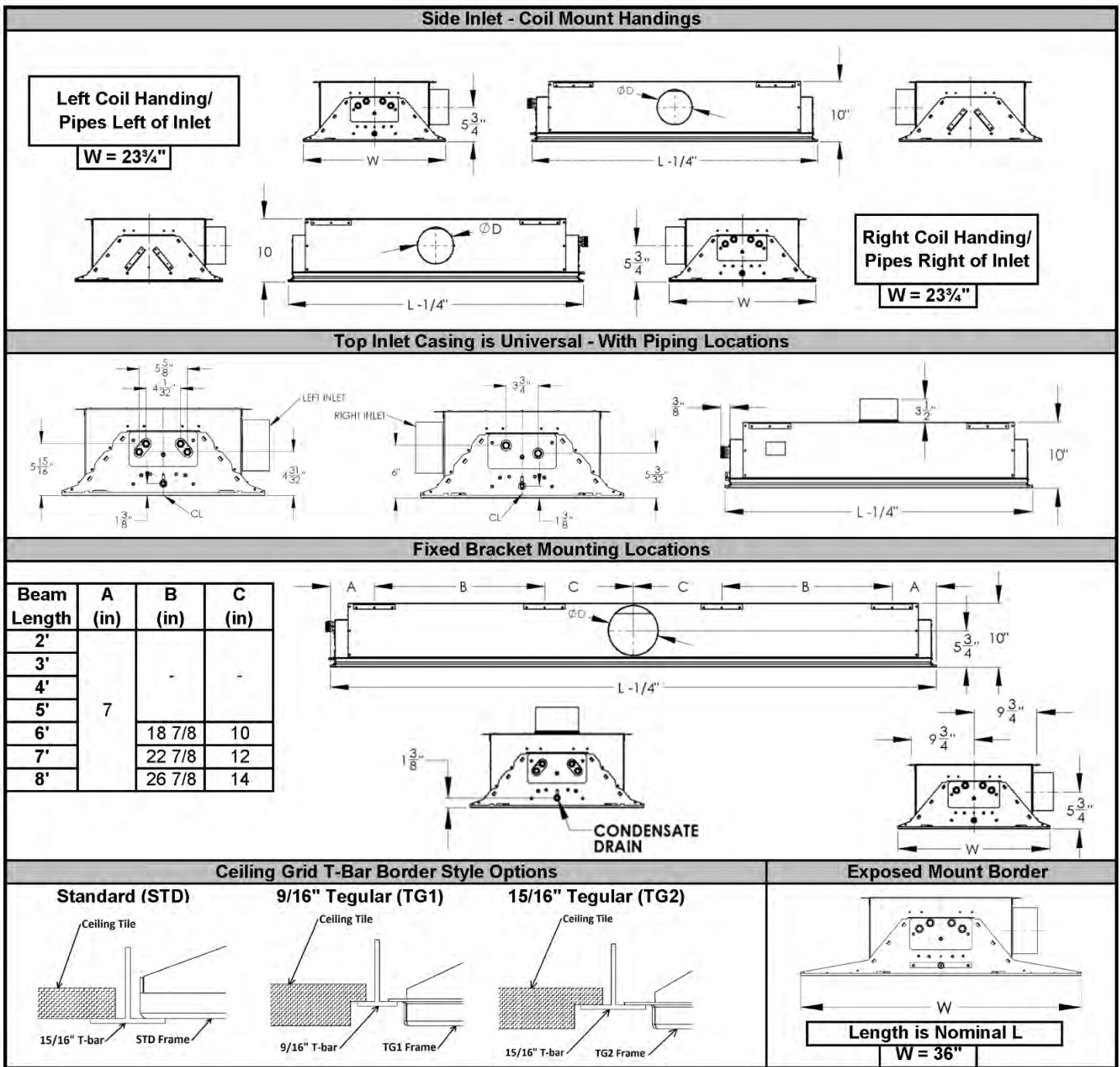

### 3.1 GENERAL PROCEDURE

The CB-S24 ceiling and exposed mounted active chilled beams from 2 feet to 5 feet in length come standard with four fixed mounting brackets. Chilled beams 6 feet to 8 feet come with 8 fixed mounting brackets. The chilled beam locations and designation should be installed according to approved ceiling plans specifications. Mounting of the chilled beams should be suspended above the ceiling grid location. The use of 3/8" threaded rods or adjustable hanging wires attached to Uni-Strut/ speed rails mounted onto the structure above the chilled beams. Once ceiling is installed, lower the chilled beams onto the T-bar ceiling grid and tighten the suspension threaded nuts or adjust the wire rope cables to the desired leveled height. Connect the water supply and water return pipes up to the chilled beams hydronic coil. Pipe connections can be made with hard solder piping or flexible stainless steel hoses. Connect the supply air to the chilled beams plenum duct connection. The supply air connection can be connected with either a hard duct or flex duct. It is important to ensure the supply air connection is sealed properly to reach the selected chilled beam performance.

Each chilled beam leaves the factory individually boxed and tagged. Each chilled beam is also tagged and provided with a K-Factor commissioning label. Each chilled beam is wrapped with a paint protective film. The chilled beams should remain in the box until they are ready to install. The paint protective film should only be removed just prior to water and airside commissioning.



### 3.2 INSTALLATION CONSIDERATIONS

- Extreme caution should be taken to ensure the correct chilled beam is installed in the right location to avoid performance issues within the room.
- Proper paint protection film should remain on the chilled beam during installation until the water and airside commissioning occurs. Avoid allowing contaminants such as construction dust or debris to collect on the equipment.
- Keep the perforated grille face and the plenum duct inlet covered at all times during the installation process.
- Coil piping should be kept protected and avoid bending the copper piping. Chilled beams should not be lifted by the hydronic coil piping connections.
- Chilled beams should be lifted in place by a lifting table or scissors lift.

- If the chilled beams are removed from packaging, they should be placed with the perforated face in the upwards position to avoid damage to the screen. No stacking on the perforated grille face is permitted.
- If chilled beams are to be storage, they should be in a clean and dry covered location.
- Perforated grille can be hinged to swing down in opposite direction if needed. See "Note" in section 4.2.1 for further details.

### 3.3 INSTALLING THE CB-S24

#### STEP 1:

Determine appropriate beam locations and positioning shown in the approved ceiling plans specifications. Refer to the design documents for the chilled beam placement within the ceiling grids.

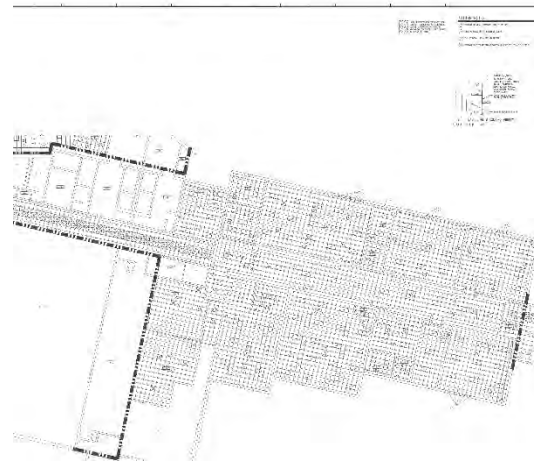

#### STEP 2:

Mount Uni-Strut/ speed rails onto the structure above the chilled beam with appropriate hardware to support full weight of the chilled beam.



#### Note!

Fixed anchor hardware is dependent on building design and structure requirement. The fixed anchor hardware is to be determined by others. See Mechanical Specifications by Engineer.

#### Uni-Strut/ Speed Rail Example



**STEP 3:**

Install the adjustable hanging suspension wire or 3/8" threaded rod, flat washers, and nuts onto Uni-Strut/ speed rail to support all four corners of 2 ft – 5 ft beams as well as two middle supports for 6 ft - 8 ft beams. See dimensional data on Page 5.



**Note!**

Only use approved local building code 3/8" threaded rods or adjustable hanging wires. Additional seismic mounting requirements as specified by the Engineering specifications. See Mechanical Specifications by Engineer.

**Uni-Strut/ Speed Rail with Threaded Rod Example**

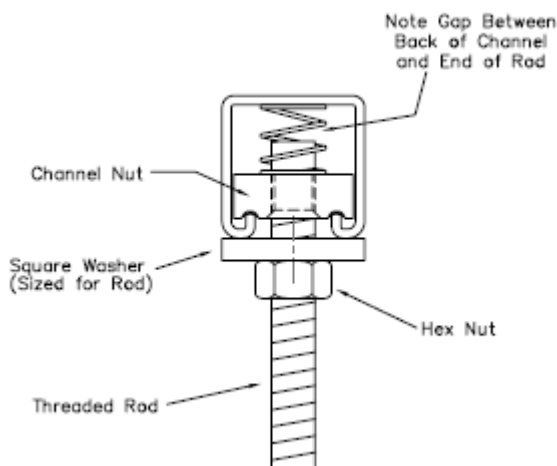

**Uni-Strut/ Speed Rail with Adjustable Hanging Wire Example**



**STEP 4:**

Position the chilled beam in accordance with the ceiling plan specifications. Refer to the design documents for the chilled beam placement within the ceiling grids.

**STEP 5:**

Lift the chilled beam into place and loop and tighten the adjustable hanging suspension wire through the slots of the chilled beam mounting brackets (adjust to desired height). If using 3/8" threaded rod, insert threaded rods into the slots of the chilled beam mounting brackets. Use flat washers and nuts and tighten to desired height onto Install 3/8" suspension nut on threaded rod.



**STEP 6:**

Adjust and level chilled beams 2 to 3 inches above the finished ceiling height for dropped ceiling installations or at ceiling level for exposed mounted border style chilled beams using a level.

**STEP 7:**

Once ceiling T-bar grid is installed lower beams onto grid by adjusting the hanging suspension wire or 3/8" threaded rod. Make sure the beams are level and fit into the ceiling T-bar grid system.

**STEP 8:**

Connect the water supply and return piping to the chilled beams hydronic coil. Hard pipe connections or flexible hose can be used (See Section 3.4). Stainless steel flexible hoses are recommended for installation ease in confined space and can be purchased separately or as part of the chilled beam package from Carson Solutions.

**STEP 9:**

Connect the supply air duct to the chilled beams plenum duct connection. The supply air connection can be made with either a hard duct or flex duct. (See Section 3.5).

### 3.4 WATER CONNECTIONS

The CB-S24 unit is fitted with 2 or 4 water pipes which come with 1/2" NPT threaded male connections. Each coil is factory tested for leakage and provided clean and capped. Caps shall not be removed until unit piping installation is in process.

**Note:**  
When installing a two-pipe design, connect only the outside pipes if a four-pipe coil was supplied.

**STEP 1:**

Identify the warm and/or chilled water supply connections on the CB-S24 chilled beam. (See Section 3.4.1).

**STEP 2:**

Remove the plastic caps before making the final water connections.

**STEP 3:**

Make the water connections to the hydronic coil piping using flexible braided stainless-steel hoses (1/2" female NPT's to connect to coil). Hard copper piping may also be used. Proper sealing techniques should be applied. Refer to Division 23 Section 23 21 13 "Hydronic Piping", connect coils to supply connection with shutoff valve, strainer, control valve, and union or flange, and to return with balancing valve and union or flange. Piping specialties are supplied by others.



**Extreme Caution!**

Do NOT over-tighten NPT fittings. Applying excessive force on the water pipes may cause damage to the hydronic coil or the water connections themselves and is not covered under warranty.

Carson Solutions optional Stainless Steel Flexible Hoses (contact your factory rep to purchase).



#### 3.4.1 WATER CONNECTIONS IDENTIFICATION

Piping connections for standard 2-pipe and 4-pipe CB-S24 chilled beam to be operated and connected as shown below.

**2-PIPE HEATING OR COOLING CONNECTION**

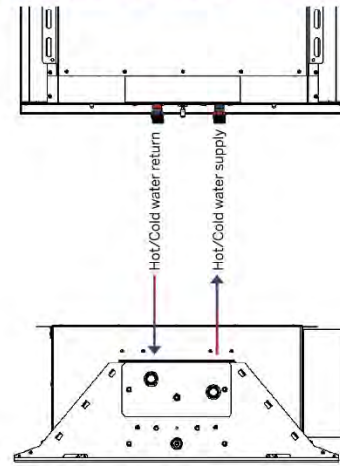

**4-PIPE HEATING & COOLING CONNECTION**

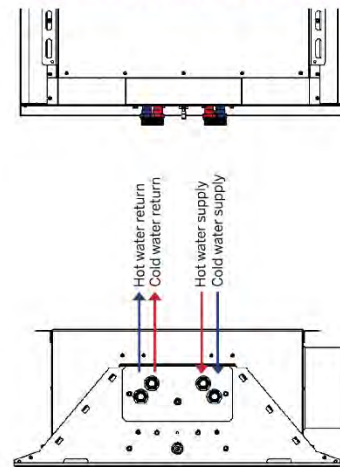

Piping should be insulated and properly labeled in accordance with local building codes, similar to what is shown below.





### 3.5 AIR CONNECTIONS

**STEP 1:**



**Note:**  
The CB-S24 chilled beam operates at higher terminal pressures than diffusers in standard VAV systems therefore the ductwork and connections feeding the chilled beam must be thoroughly sealed to prevent excessive leakage.

The air connections should include a minimum of three duct diameter lengths of straight ductwork upstream of the CB-S24 connection to ensure laminar flow and prevent noise generation. Straight ductwork connections will yield a reliable pressure port measurement.

Air connections can be made with either hard-pipe (most common) or with flexible duct. If using flexible duct, limit duct length to a maximum of 5ft.

Properly seal ductwork with either foil HVAC aluminum tape or with duct sealant mastic. The inner duct connection must be fully sealed to prevent leakage and loss of performance.



Ensure there is an airtight connection between the supply duct and each CB-S24 duct connection. Duct connections should meet SMACNA class B standard up to 2 in. W.G. Refer to Division 23 – Heating, Ventilation and Air Conditioning (HVAC) Section 23 31 13.01 “Metal Ducts” and or Section 23 07 13 “Duct Insulation” for additional information.

### 3.6 FLUSHING THE WATER PIPING SYSTEM

Before flushing the water system, close all valves that isolate the CB-S24 units and flush the main piping system first. Refer to Division 23 Section 23 25 00 “Pipe Cleaning, Flushing, and Chemical Treatment”.

### 3.7 FILLING AND VENTING THE WATER SYSTEM

To ensure easy venting, the main pipes should be installed at a higher level than the CB-S24 units. The horizontal pipes should be installed rising slightly towards the venting points.



**Note:**  
There should be no high points to create air pockets within the system.

Before filling, all shut-off and control valves must be in the fully open position. The pumps should not be running during the filling processes (static filling). Continuous venting is necessary during this process. The installation of both manual and automatic venting systems is recommended. The pump should only be started when filling is complete. To remove all air from the system, the majority (>75%) of the system should be closed so that the water can circulate at a sufficient rate. When each section is full, it should be closed, and the procedure repeated throughout the system.



**Note:**  
Use ONLY non-chilled water when filling up the system! Cold water can cause immediate condensation on the pipes. Warm water contains less oxygen which can restrict venting.

### 3.8 CONNECT CONDENSATE DRAIN

If the specifications call for plumbing the drain connection, remove the drain cap located on the side of CB-S24 beam. The drainpipe connection will be located on the same side as the hydronic heat exchanger pipe connections. Use a 1/4” flexible plastic tubing or 1/4” PVC tubing and connect it to the condensate pumping system.

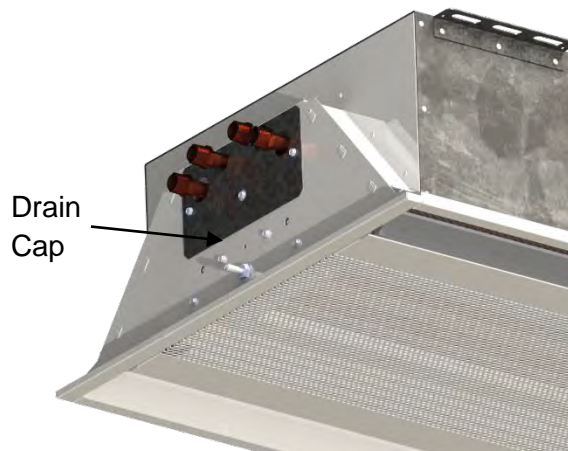

## 4.1 WATERSIDE COMMISSIONING



**Important:**  
Commissioning is to be performed by properly trained and authorized personnel only!

- Fully purge the complete hydronic system of air prior to commissioning.
- Carefully inspect the system for leaks, paying particular attention to the connections.
- Carefully inspect flexible hose for leaks, if applicable.
- For the face coils normal operating pressure is rated at 250 psig max up to 300°F. The maximum working pressure should not exceed 360 psi.



**Note:**  
The CB-S24 unit is not provided with any water flow control or measuring devices, therefore the pipe work system should be fitted with sufficient balancing aids to enable adjustment of the flow rate.

## 4.2 AIRSIDE COMMISSIONING



**Note:**  
Do not attempt to read the total discharge airflow rate using a hood or any other device that adds downstream pressure to the unit, as it will reduce the amount of induction and give false readings. The total supply air flow (primary + induced) cannot be measured.

**NOTE:** Using a traverse duct calculation of the supply duct before the CB-S24 will not guarantee that the chilled beam is properly balanced because performance is based on internal plenum pressure.

### 4.2.1 AIRSIDE COMMISSIONING AND K-FACTOR TABLE



**Note:**  
The constraints detailed in the table below are for standard CB-S24. For CB-S24's with non-standard nozzle configurations, contact Carson Solutions directly.

#### STEP 1

Unlatch and swing down the hinged perforated grille. Two people, each standing on an appropriate ladder, is recommended for chilled beams longer than 4 feet to unlatch and swing down grille. Avoid allowing the grille to hit the fins on the hydronic coil.

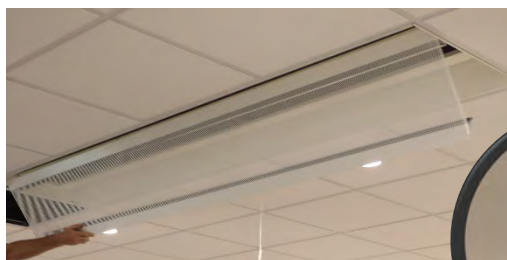

**Note:**  
The perforated grille swing direction can be changed by unlatching the two locks visible once the grille has been swung down. For safety it is recommended to have two people perform this operation.



#### STEP 2

Locate the commissioning air tap near the hydronic coil.

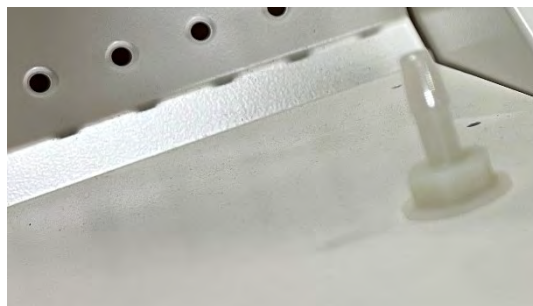

#### STEP 3

Use the commissioning tube to measure the internal pressure of the plenum.



**STEP 4**

The primary air flow rate is determined by measuring the static pressure in the primary air chamber and referring to the calibration chart label provided on each chilled beam.



Make necessary adjustments to the balancing damper for the desired scheduled static pressure to the measured result. Adjusting the balancing damper should be used for trimming only.

Gently swing the perforated grille back into position and relatch the lock pins. It is recommended to use two people for this step.

Refer to Division 23 Section 23 05 93 “Testing, Adjusting, and Balancing” for additional procedures for chilled beams adjusting and balancing.

**Volume Flow Controller (optional) general information:**

If a volume flow rate control is required, a volume flow controller (supplied by others) may be installed in a constant volume system. See manufactures information specifications for further details.

Carson Solutions offers a range of volume flow rate controllers. Please contact Carson Solutions for more information.



Typical volume damper shown

The primary air volume in CFM can be calculated with this formula and the K-Factor value in the charts below: Data on the charts below are given at Standard Atmosphere at sea level.

$$CFM = K \times \sqrt{\Delta P}$$

CFM = primary airflow (CFM)

K = constant - read from Tables below

$\Delta P$  = static pressure measured in primary air chamber (in. W.G.)

**CB-S24 2-Way K-Factor Chart**

Carson Solutions Active Chilled Beam CB-S24 2-Way				
Size	K-Factor Chart			
	Nozzle Size			
	2R	3R	4R	6R
2'	70	39	20	13
3'	116	65	34	22
4'	163	90	48	31
5'	209	116	61	40
6'	255	142	75	49
7'	302	168	88	58
8'	348	194	102	67

1. Measure nozzle pressure using the pressure tap port located by releasing swing down grill.  
 2. Use a 1/4" hose to attached to the low pressure side of the Manometer.  
 3. Measure and record the nozzle pressure  $P_{TAP}$  in. W.G.  
 4. Calculate the primary airflow rate by inserting the constant K for the beam length and the pressure measurement  $P_{TAP}$  into the equation below.  $CFM = K \times \sqrt{P_{TAP}}$

Scan to view ID1M 

**CARSON SOLUTIONS™**  
www.carsonsolutions.com

**Example:** Size 4ft CB-S24, 2-Way, 3R-nozzle

Measured static pressure of 0.31 in. W.G.

K = 90 (from table above)

$$CFM = 90 \times \sqrt{0.31}$$

$$= 50 \text{ CFM}$$

## 5.1 CLEANING INSTRUCTIONS

The CB-S24 units contain no moving or consumable parts, therefore the maintenance requirements are limited to periodic inspection for leakage and occasional cleaning of the hydronic coil and grille.

The accumulation of dust on the hydronic coil will eventually restrict the airflow through the coil, reducing cooling and heating performance.

The inspection frequency is subject to the environmental conditions and occupancy levels. It is recommended that the CB-S24 units be inspected on an annual basis until a scheduled maintenance pattern is established.



### Important!

Maintenance is to be performed by properly trained and authorized personnel only!

Properly maintain water conditions which prevent corrosion of copper tubing if included in the system design, check the condensate sensors or humidity sensors according to sensor manufacturer's methods and schedule.



### Important!

Wear eye protection and gloves.  
Product includes sharp edges and burrs.

To clean the hydronic coil, it is required to access the coil from the room side by swinging down the hinged perforated grille and vacuuming the hydronic coil with a soft bristle brush.

### STEP 1

Unlatch and swing down the hinged perforated grille. Two people with ladders is recommended for chilled beams longer than 4 feet to unlatch and gently swing down grille. Avoid allowing the grille to hit the fins on the hydronic coil.



### STEP 2

Using a soft nozzle brush attachment, gently vacuum in the direction of the coil fins to remove any accumulated dust. Be careful not to bend or damage any fins. A fin comb can be used to straighten any bent fins if needed.



### STEP 3

Once the hydronic coil has been cleaned, gently swing the perforated grille back into position and relatch the lock pins. It is recommended to use two people for this step.

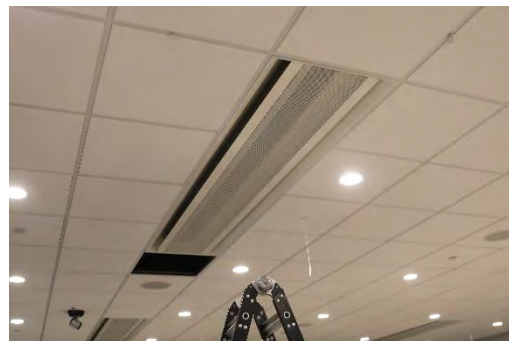

### To clean the CB-S24 unit:

When necessary, the painted casing can be cleaned using a mild detergent diluted with warm water. Apply with a soft cloth, rinse, and wipe dry.



### Note!

Strong or abrasive chemical detergents should not be used as they may cause damage to the paint finish.

## 5.2 REPLACEMENT PARTS

The CB-S24 chilled beam contains no serviceable or consumable parts. Contact Carson Solutions for more information.

6.1 SYMPTOMS & SOLUTIONS

SYMPTOM	PROBABLE CAUSE	SOLUTION
<p><b>LOSS OF AIRFLOW</b></p>	<p>Obstruction on perforated grille or hydronic coil</p>	<p>Remove perforated grille inspect/clean grille and hydronic coil as necessary</p>
	<p>Air connection detached from chilled beam</p>	<p>Inspect attachment hardware and reconnect ductwork</p>
	<p>Obstruction in primary air plenum</p>	<p>Remove primary air connection and check for debris</p>
	<p>Air dampers incorrectly set</p>	<p>Inspect and adjust air damper as necessary</p>
	<p>Faulty or incorrectly set air handling unit</p>	<p>Inspect and re-commission air handling unit (by certified contractor)</p>
<p><b>REDUCED COOLING OR HEATING</b></p>	<p>Reduced cooling or heating performance</p>	<p>Confirm primary airflow is at designed CFM or above</p>
	<p>Obstruction on front face panel or hydronic coil</p>	<p>Remove front face panel and inspect/clean grille and hydronic coil as necessary</p>
	<p>Loss of water circulation through hydronic coil</p>	<p>Inspect control valves and check flow using system test points</p>
<p><b>CONDENSATION ON PIPE-WORK OR HYDRONIC COIL</b></p>	<p>Chilled water temperature too low</p>	<p>Measure chilled water temperature and reset to design value</p>
	<p>Incorrect primary air temperature or condition</p>	<p>Measure room humidity level. If humidity is higher than design condition, the primary air is failing to control room humidity. The air handling unit must be set so the primary air is dry enough to offset the latent gains</p>
	<p>Primary air volume too low</p>	<p>Measure primary air volume using procedure described in section 4.2.1 Increase air volume design figure</p>

## 7.1 MANUFACTURER'S REPRESENTATIONS & WARRANTIES

**CARSON DESIGN MANUFACTURING (CDM), INC. DBA (CARSON SOLUTIONS) TERMS & CONDITIONS OF SALE Version 01-01-22 ALL SALES ARE SUBJECT TO THESE TERMS AND CONDITIONS OF SALES ("TERMS") AND AS CONTAINED IN CDM'S INVOICE AND ARE ALSO SUBJECT TO CDM'S CREDIT AND OTHER POLICIES AND PROCEDURES, WHICH ARE HEREBY INCORPORATED BY REFERENCE AND SUBJECT TO CHANGE.**

**1. TERMS TO GOVERN:** These Terms shall be binding upon CDM Inc, and its subsidiaries and affiliates ("Seller") and the buyer ("Buyer"). No modification, amendment or change, whether in Buyer's purchase order, shipping release forms or otherwise shall obligate Seller, unless authorized in writing by Seller. Any different or inconsistent terms and conditions contained in Buyer's forms whether issued before or after Seller's quotation are hereby expressly superseded by these Terms.

**2. ACCEPTANCE & PRICES:** Any proposal offered by Seller to Buyer is valid for sixty (60) days from Seller's issuance. Upon the expiration of sixty (60) days or sooner if revoked by Seller, the proposal shall expire. Pricing shall remain valid for Seller's products shipped within 90 days from the date of Seller's acceptance. Thereafter, prices are subject to change. Prices include transportation charges predicated on a single shipment and any partial shipments may result in additional cost to Buyer. Seller reserves the right, at any time, to withdraw a bid, quote or a price that contains an error.

**3. PAYMENT & TAXES:** Upon credit approval, payment terms for Products shipped hereunder or labor performed will be thirty (30) days net with no retainages unless contrary terms appear on the face hereof or otherwise expressly agreed to in writing by Seller. Should Buyer default in the timely payment to Seller of sums due on an order, Seller is entitled to any remedies provided in these Terms or by law. If Buyer fails to pay any amounts when due, Buyer shall pay Seller interest thereon at a periodic rate of the lesser of one and one-half percent (1.5%) per month or the maximum allowable legal interest rate, along with all costs and expenses (including without limitation mechanics lien or bond, collection expenses, reasonable attorneys' fees, filing and service fees and disbursements and Court costs) incurred by Seller. Buyer is responsible for all sales, customs, or use tax imposed by any governmental agency, including, but not limited to, Federal, State, Local or international authorities, payable on the transaction under any applicable statute, except those taxes due as a result of Seller's gross profits. If Seller is not timely paid or Buyer is otherwise in default, Seller reserves the right to pause or terminate any work or services in process and/or reschedule any delivery at any time.

**4. PERFORMANCE:** Seller shall be obligated to furnish only the Products or labor described in the applicable purchase order or acknowledgement and agreed to in writing. The duty to perform under any order on the part of Seller and the price thereof is subject to the approval of its Credit Department, and is contingent upon the absence of strikes, accidents, floods, act(s) of terrorism, war, fires, fuel shortages, the inability to procure materials from the usual sources of supply, the requirements of the US Government (through the use of priorities or preference or any other manner) that Seller divert either the material or the furnished Product to the direct or indirect benefit of the US Government, or upon any like or unlike cause beyond the reasonable control of Seller. Upon disapproval of the Credit Department or upon the occurrence of any such event, Seller may delay performance or, at its option, renegotiate prices and terms and conditions of sale with Buyer. If Seller elects to renegotiate and Seller and Buyer are unable to agree on revised prices or terms, Seller may cancel without any liability.

**5. SHIPMENT & RISK OF LOSS:** Shipment dates are estimates only, FOB factory. Title and risk of loss shall pass to Buyer upon Seller's delivery to carrier. Customers may only make their own shipping arrangements with Seller's agreement. Seller shall advise when the Products have been completed and send an invoice at that time. All Product must be picked up by Buyer within 30 days of Seller's completion of manufacture. Seller specifically rejects any order containing a time is of the essence clause or liquidated damage penalties for late shipments. Seller is not responsible for loss of goods from shortages, damages or transit delays. Any claims for damage in shipment, mis-delivery, loss of the Products or other damage shall be the responsibility of and filed by Buyer.

**6. CHANGES, CANCELLATION & RETURNS:** Changes requested by Buyer following Seller's acceptance of order must be approved by Seller in writing and may result in an increase in price by Seller to recover all labor and material costs, including normal overhead and profit. If any portion of a Seller accepted order is cancelled by Buyer without default on the part of Seller or without Seller's written consent, Buyer shall be liable to Seller for cancellation charges including, but not limited to, Seller's incurred costs and the profit Seller would have realized from the transaction had the agreement not been breached by Buyer. Products shall not be returned except by written permission of Seller pursuant to Seller's return policy.

**7. AUTHORITY OF AGENTS:** No agent, employee or representative of Seller has the authority to bind Seller to any affirmation, representation or warranty concerning the Product or labor sold, except for Seller's authorized agents, employees or representatives.

**8. INDEMNITY:** Seller shall protect and indemnify Buyer from and against all claims, damages, judgments and loss solely arising from Seller's infringement or alleged infringement of any United States patent by any of the articles or material delivered hereunder, provided that in the event of suit or threat of suit for patent infringement, Seller shall promptly be notified and given full opportunity to negotiate a settlement. Seller does not warrant against infringement by reason of Buyer's design of the articles or the use thereof in combination with other materials, or in the operation of any process. In the event of litigation, Buyer agrees reasonably to cooperate with Seller. All parties concerned shall be entitled, in connection with any proceeding under the provisions of this Article, to be represented by counsel at their own expense. Buyer shall defend, indemnify and hold Seller harmless from any personal injury, wrongful death or property damage caused in whole or in part by Buyer's breach, negligent or intentional act(s).

**9. LIMITED WARRANTY:** Seller warrants that at the time of delivery and for a period of twelve (12) months from the initial startup ("Start-Up"), or eighteen (18) months from date of shipment, whichever is less, Products will be free from defects in material and manufacture provided that Products have been installed with proper Start-Up, maintained and operated under normal conditions for service in accordance with the instructions of Seller, and that Products have the capacities and ratings set forth in Seller's design specifications. No warranty is made against corrosion, erosion or deterioration. At Seller's option, Seller's obligations and liabilities under this warranty are limited to repair of Products or replacement of components for Products not conforming to this warranty. This Limited warranty does not cover labor for component repair or replacement. Once Seller's service department has been notified and approved any warranty related service work, Seller will repair or replace components as needed and ship FOB factory. Seller shall not be obligated to pay for the cost of lost refrigerant or Glycol. Consumable parts and Products that are consumable in nature are explicitly excluded from this warranty. Consumables include, but are not limited to, filters, glycol and refrigerant. No warranty or liability whatever shall attach to Seller until full payment has been received. No warranty herein extended shall apply to repair or correction of conditions arising from improper or incorrectly connected air duct, piping, wiring, power supply, blown fuses, freezing, improper Product control when programmed by non-Seller controls, or personnel, or by anyone other than Seller employee or its representative. Operation of Products for temporary conditioning of a building during construction without the written consent of an officer of the Seller immediately voids any warranty coverage. If the Product is replaced, the replacement may not be new, but will be in good working order and at least functionally equivalent to the item or Product replaced. The replacement assumes the warranty status of the replaced Product. The warranty period does not restart. **THIS LIMITED WARRANTY IS VOIDED BY MISUSE, NEGLIGENCE, FAILURE TO FOLLOW INSTRUCTIONS OR SELLER'S MANUALS OR TAMPERING WITH, THE PRODUCTS PERFORMED BY ANY PERSON OR ENTITY OTHER THAN SELLER WITHOUT SELLER'S PRIOR WRITTEN APPROVAL OR ANY USE OF REPLACEMENT PARTS NOT SUPPLIED BY SELLER. THE WARRANTY AND LIABILITY SET FORTH HEREIN REPRESENT BUYER'S EXCLUSIVE REMEDY AND ARE IN LIEU OF ALL OTHER WARRANTIES AND LIABILITIES WHETHER IN CONTRACT, TORT, WARRANTY OR IN NEGLIGENCE, EXPRESSED OR IMPLIED, IN LAW OR IN FACT, INCLUDING IMPLIED WARRANTIES OF MERCHANTABILITY AND FITNESS FOR A PARTICULAR USE. SELLER PROVIDES NO INDEPENDENT WARRANTY FOR THIRD PARTY PRODUCTS OR COMPONENTS SOLD TOGETHER OR INCORPORATED WITH SELLER'S PRODUCT(S).**

**10. LIABILITY DISCLAIMER:** TO THE MAXIMUM EXTENT PERMITTED BY LAW, SELLER'S TOTAL LIABILITY FOR CLAIMS, REGARDLESS OF THE FORM OF ACTION OR THEORY OF LIABILITY (INCLUDING CONTRACT, TORT OR WARRANTY), SHALL BE LIMITED TO THE FEES PAID TO SELLER BY BUYER FOR THE PRODUCTS OR LABOR THAT WAS THE PROXIMATE CAUSE OF THE DAMAGE. IN NO EVENT SHALL SELLER BE LIABLE TO BUYER FOR ANY INCIDENTAL, CONSEQUENTIAL, SPECIAL, PUNITIVE, OR INDIRECT DAMAGES OF ANY KIND (INCLUDING, WITHOUT LIMITATION, LOST PROFITS, LOSS OF USE, OR CLAIMS OF THIRD PARTIES) THAT MIGHT OCCUR AS A RESULT OF THE PERFORMANCE OR BREACH OF THE AGREEMENT OR IN ANY WAY ARISING OUT OF OR IN CONNECTION WITH THE AGREEMENT WHETHER BY CONTRACT, TORT, WARRANTY OR OTHERWISE. SELLER SHALL NOT BE LIABLE OR RESPONSIBLE FOR ANY CRANE, RIGGING, LABOR OR OTHER CHARGES OR DAMAGES OF ANY KIND OR NATURE CAUSED IN WHOLE OR IN PART BY DELAYS IN SHIPMENT OR SELLER'S BREACH.

**11. ASSIGNMENT:** Buyer may not assign or transfer this agreement. Seller may assign its rights or obligations under this Agreement in the event of a merger or change of control of Seller.

**12. GOVERNING LAW:** This Agreement shall be governed and construed in accordance with the laws State of Minnesota. Buyer consents to jurisdiction in the Circuit Court of Hennepin County, Minnesota. Each party consents to that choice of law and jurisdiction and irrevocably waives any objection to same.

**13. EXPORT CONTROLS:** Buyer shall comply with the export laws and regulations of the United States. Buyer agrees it shall not export or enter into an agreement for the export any goods from Seller to any prohibited or embargoed country or to any denied, blocked or restricted person or entity.

**14. MISCELLANEOUS:** Seller's waiver or failure to enforce the terms of this Agreement shall not constitute a waiver of Seller's rights. The prevailing party may recover their reasonable attorney fees and reasonable out-of-pocket expenses.

